

Absolute encoders - analog

Through hollow shaft $\varnothing 10$ to $\varnothing 14$ mm

Optical single- or multiturn encoders with analog output

ATD 2A A 4 Y 7



ATD 2A A 4 Y 7 with through hollow shaft

Features

- Encoder multiturn / analog output
- Voltage output or current output
- Control inputs reset and rotating direction
- Optical sensing method
- Self-diagnostic
- Total resolution: 16 bit
- Factory-set adjustable angle (0° - 360° resp. up to $1024 \times 360^{\circ}$)
- Flange connector radial

Technical data - electrical ratings

Voltage supply	+UB= 12...30 VDC (IS-/IE-/US-/UT-version) -UB= -12...-26 VDC / +UB 12...30 VDC (UE-/UR-version)
Reverse polarity protection	Yes
Consumption w/o load	≤ 70 mA (24 VDC)
Interface analog	IS (current output, 4...20 mA) IE (current output, 0...20 mA) US (voltage output, 0...10 VDC) UE (voltage output, -10...+10 VDC) UT (voltage output, 0...5 VDC) UR (voltage output, -5...5 VDC)
Function	Singleturn, Multiturn
Measuring range	90° , 180° , 360° 2, 4, 8, 16...1024 revolutions
Load resistor	≥ 1 k Ω (recommended 10 k Ω) / voltage output ≤ 500 Ω (recommended 470 Ω) / current output
Resolution	16 bit
Steps per turn	16384 / 14 bit
Number of turns	1024 / 10 bit
Sensing method	Optical
Updating values	≤ 130 μ s
Code sequence	CW: ascending values with clockwise sense of rotation; looking at mounting surface
Output stages	Voltage output (short-circuit proof) Current output (short-circuit proof)
Interference immunity	DIN EN 61000-6-2
Emitted interference	DIN EN 61000-6-3

Technical data - mechanical design

Size (flange)	$\varnothing 58$ mm
Shaft type	$\varnothing 10$ mm (through hollow shaft) $\varnothing 12$ mm (through hollow shaft) $\varnothing 14$ mm (through hollow shaft)
Protection DIN EN 60529	IP 65
Operating speed	≤ 8000 rpm (mechanical) ≤ 6000 rpm (electric)
Starting torque	≤ 0.02 Nm ($+20^{\circ}$ C)
Materials	Housing: aluminium Shaft: stainless steel
Operating temperature	-20 ... $+85^{\circ}$ C
Relative humidity	90 % non-condensing
Resistance	DIN EN 60068-2-6 Vibration 10 g, 55-2000 Hz DIN EN 60068-2-27 Shock 30 g, 11 ms
Weight approx.	325 g
Connection	Connector M23 type 2, 12-pin
Motor shaft tolerance	0.25 mm axial 0.1 mm radial
Mounting kit	002

Absolute encoders - analog

Through hollow shaft $\varnothing 10$ to $\varnothing 14$ mm

Optical single- or multiturn encoders with analog output

ATD 2A A 4 Y 7

Part number

ATD 2A A 4 Y 7

		D2SR12	S		IP65	002
--	--	--------	---	--	------	-----

Mounting kit
002 Mounting kit 002

Protection
IP65 IP 65

Through hollow shaft
10 $\varnothing 10$ mm
12 $\varnothing 12$ mm
14 $\varnothing 14$ mm

Operating temperature
S -20...+85 °C

Connection
D2SR12 Flange connector type 2, pin contacts, radial, 12-pin

Interface
IS Current output, standard, 4...20 mA, $V_{in} = 12...30$ VDC
IE Current output, extended, 0...20 mA, $V_{in} = 12...30$ VDC
US Voltage output, standard, 0...+10 VDC, $V_{in} = 12...30$ VDC
UE Voltage output, extended, -10...+10 VDC, $V_{in} = -12...-26$ VDC / 12...30 VDC
UT Voltage output, 0...+5 VDC, $V_{in} = 12...30$ VDC
UR Voltage output, reduced, -5...+5 VDC, $V_{in} = -12...-26$ VDC / 12...30 VDC

Resolution
360A 360° mech. angle of rotation, alternating (singleturn)
180A 180° mech. angle of rotation, alternating (singleturn)
180H 180° mech. angle of rotation, High (singleturn)
180L 180° mech. angle of rotation, Low (Singleturn)
2U 2 x 360° mech. angle of rotation (multiturn)
4U 4 x 360° mech. angle of rotation (multiturn)
8U 8 x 360° mech. angle of rotation (multiturn)
16U 16 x 360° mech. angle of rotation (multiturn)

Other adjustment on request.

Accessories

Connectors and cables

11070180 Connector S2BG12, 10 m cable (ATD analog)

Absolute encoders - analog

Through hollow shaft $\varnothing 10$ to $\varnothing 14$ mm

Optical single- or multiturn encoders with analog output

ATD 2A A 4 Y 7

Output signals

Unipolar Output
(IS-/IE-/US-/UT-version)

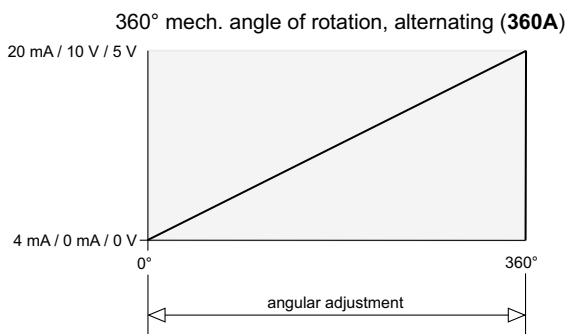

Bipolar Output
(UE-/UR-version)

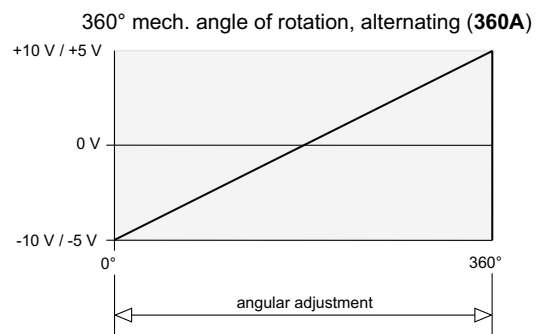

180° mech. angle of rotation, alternating (180A)

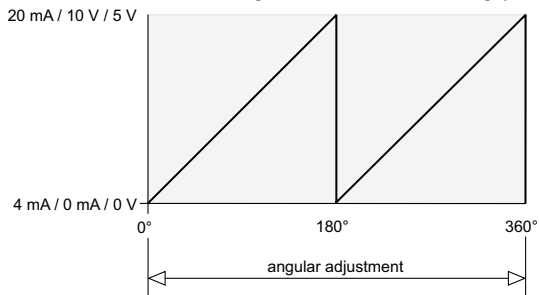

180° mech. angle of rotation, alternating (180A)

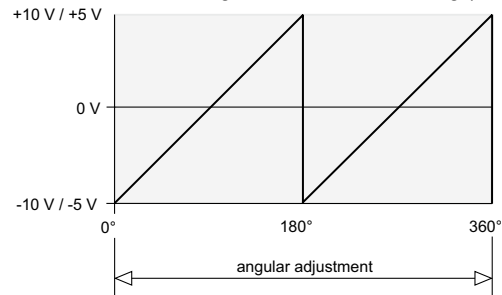

180° mech. angle of rotation, High (180H)

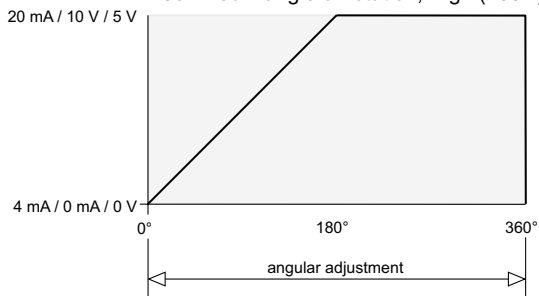

180° mech. angle of rotation, High (180H)

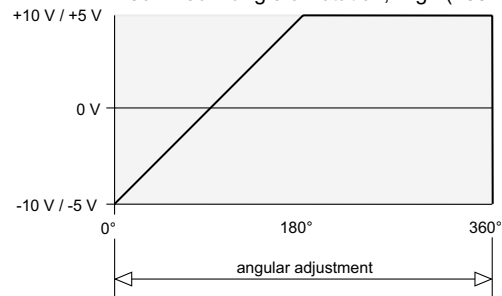

180° mech. angle of rotation, Low (180L)

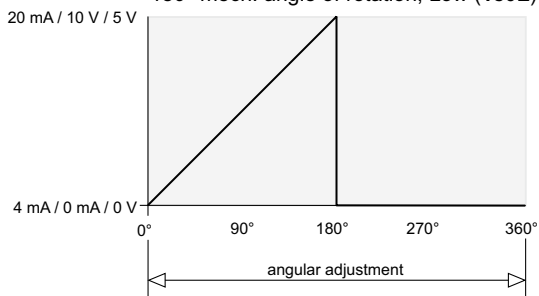

180° mech. angle of rotation, Low (180L)

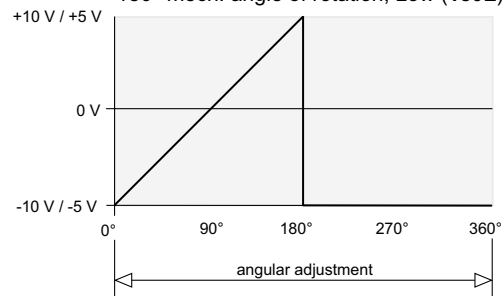

Absolute encoders - analog

Through hollow shaft $\varnothing 10$ to $\varnothing 14$ mm

Optical single- or multiturn encoders with analog output

ATD 2A A 4 Y 7

Output signals

Unipolar Output (IS-/IE-/US-/UT-version)

Bipolar Output (UE-/UR-version)

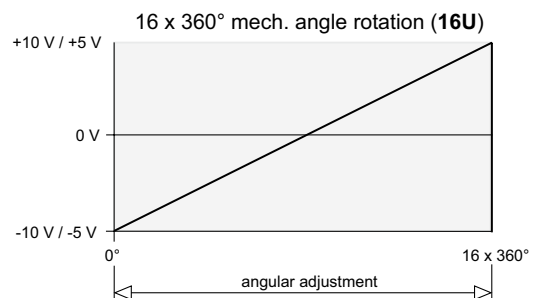
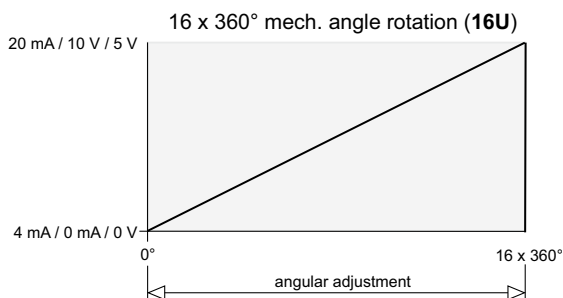
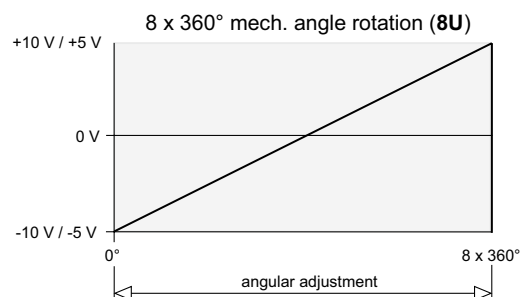
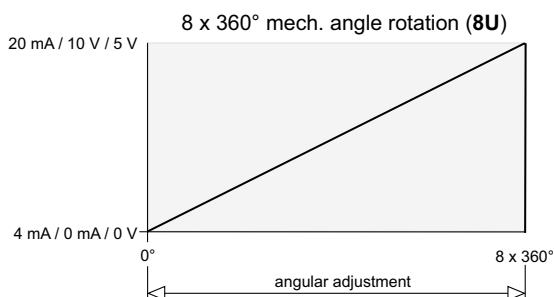
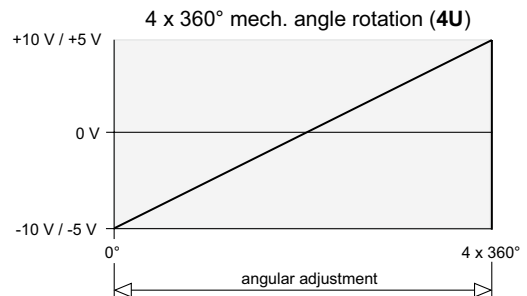
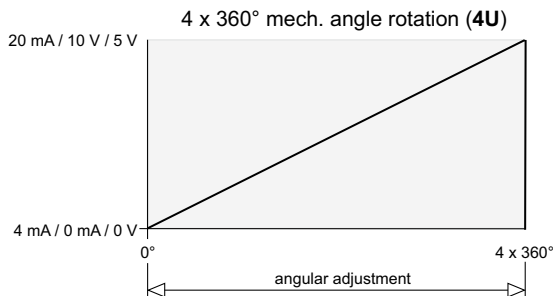
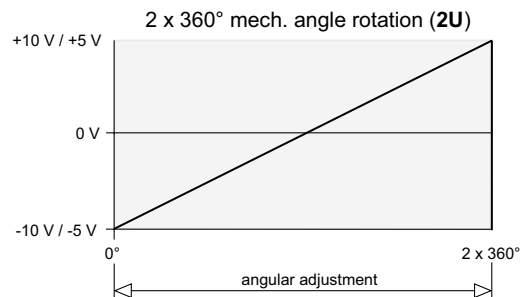
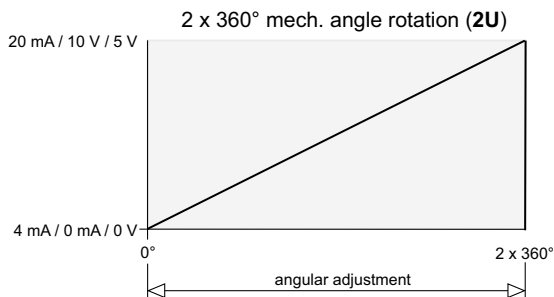
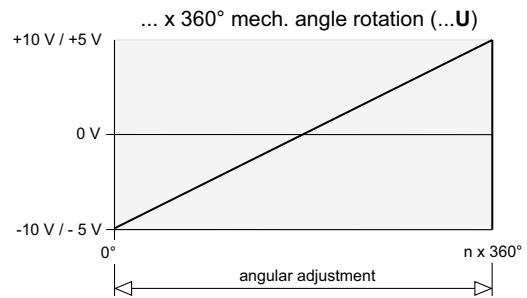
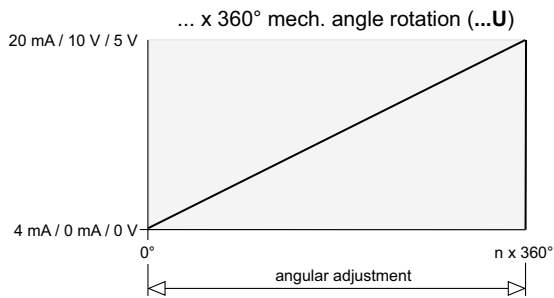

Absolute encoders - analog

Through hollow shaft $\varnothing 10$ to $\varnothing 14$ mm

Optical single- or multiturn encoders with analog output

ATD 2A A 4 Y 7

Trigger level	
Control input	Input circuit
Input level High	$\geq 0,7$ UB
Input level Low	$\leq 0,3$ UB
Input resistance	10 k Ω
Diagnostic outputs	Output circuit
Output level	Open Collector with internal 10 k Ω PullUp-resistance

Terminal significance	
+UB	Encoder supply voltage.
-UB	Negative encoder supply voltage -12 to -26 VDC (only at UE-/UR-version).
GND	Encoder ground connection relating to UB.
U _{OUT}	Voltage output increasing at clockwise rotation when looking at the mounting side.
I _{OUT}	Current output increasing at clockwise rotation when looking at the mounting side.
GND _{OUT}	Reference voltage for analogue output.
Reset	Reset input for setting zero position value at any desired point within the entire resolution. The resetting process is triggered by apply of UB.
$\overline{V/R}$	$\overline{V/R}$ counting direction input. This input is standard on High. $\overline{V/R}$ means increasing values with clockwise shaft rotation when looking at the mounting side. $\overline{V/R}$ -Low means decreasing values with clockwise shaft rotation when looking at the mounting side.
Error	Diagnostic output (Open Collector with internal 10 k Ω pullup-resistor). The output is low-active, that means if no fault submitted, the output is +UB.

Terminal assignment	
ATD 2A A 4 Y 7	
Connector	Assignment
Pin 1	-
Pin 2	-
Pin 3	-
Pin 4	GND _{OUT}
Pin 5	U _{OUT} resp. I _{OUT}
Pin 6	-
Pin 7	reset
Pin 8	$\overline{V/R}$
Pin 9	error
Pin 10	GND
Pin 11	- / -UB (only at UE-/UR-version)
Pin 12	+UB

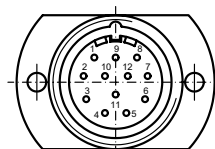

Absolute encoders - analog

Through hollow shaft $\varnothing 10$ to $\varnothing 14$ mm

Optical single- or multiturn encoders with analog output

ATD 2A A 4 Y 7

Dimensions

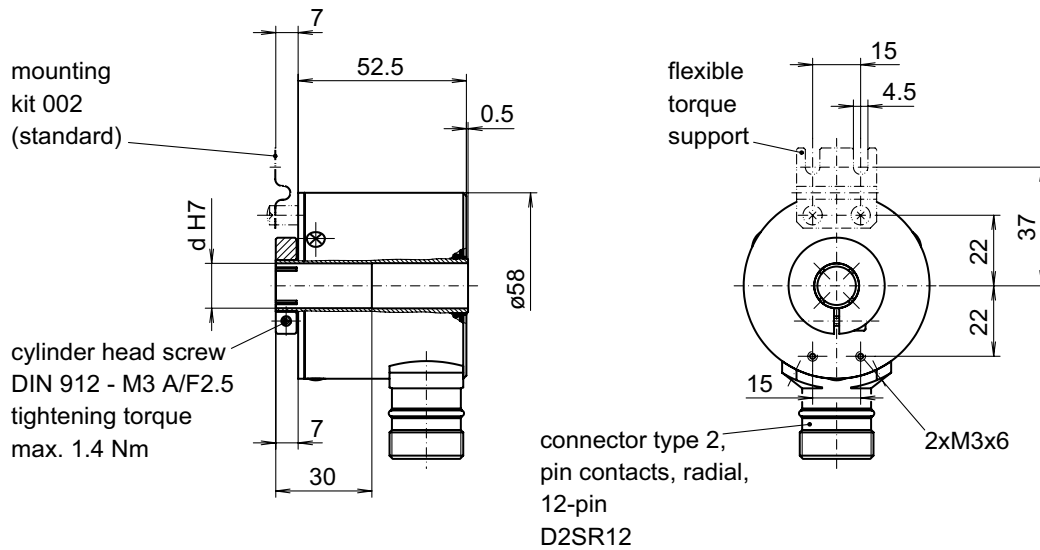

028- 5 Y 7